

SHADE ELEMENTS

Interiors

Follow this guide to measure your windows for our Roller blinds

You will need

- A tape measure that reads in millimetres, long enough to reach across your entire window
- A way to record your measurements - pen & paper

Things to consider

- An inside fit requires a window recess deep enough and gaps around the blind for free movement. Fit your blind inside the window frame for a clean look.
- An outside fit is best for blocking light and insulation, especially when it's a back roll roller blind. Fit your blind to the outside of the window frame or to the wall just above the window frame for reduced light gaps.
- Inside and outside fitting blinds will have small gaps at the sides, top and bottom of the window.
- Make sure nothing is in the way of where the blind will hang so you can open and close them fully.

Inside Fit

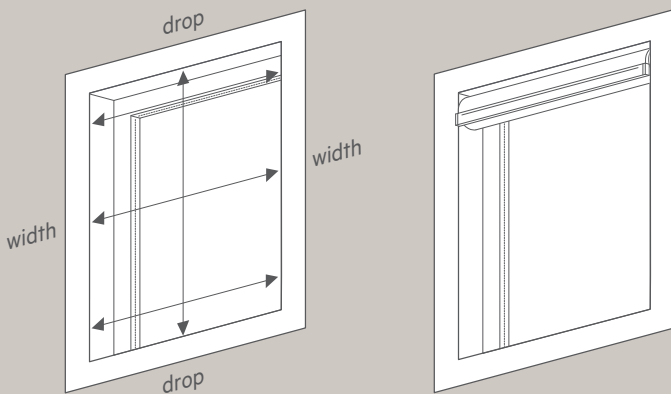

Depth

This measurement is to ensure your blind will fit within the window recess. Measure inside the frame from the front to the first obstruction, eg. glass, latch, handle or mullion. Here's a guide of how much clearance is needed:

- Roller blind - 70mm
- Dual roller blind - 85mm

Width

Take your measurement horizontally across the window at the top, middle and bottom. Measure inside the frame, from frame to frame, not only the panes of glass. Record the smallest measurement as your width.

Drop

Take your measurement vertically down the middle of the window. Measure inside the frame, from frame to frame, not only the panes of glass. Record the measurement as your drop.

Outside Fit

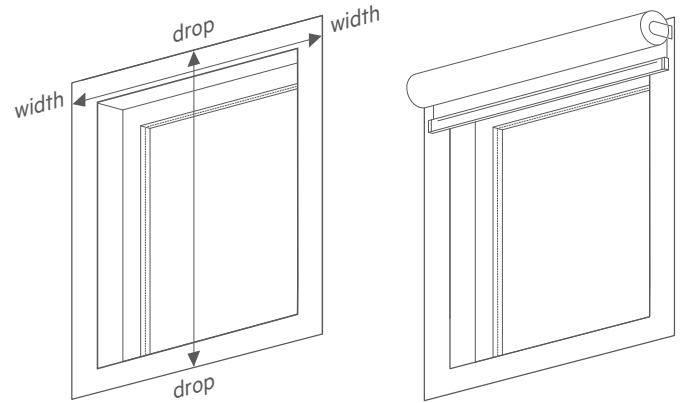

Width

For back-rolled roller blinds, fix onto the architrave or the reveal of the window frame, at the top of your window. Measure from the outer edge of the frame on one side to the outer edge on the other, and record this as your width. For front-rolled roller blinds, fix your blinds to the wall above your window for greater coverage when down.

Drop

Take your measurement vertically down middle of the window. Measure from the top of the outer edge of the window frame down to the sill, bottom of the window frame or lower if you wish and there is nothing obstructing the blind below. Record the measurement as your drop.

Tip: If fixing the blind above a window frame that is not flush with the wall, you may need to pack out the bracket enough to allow the blind to clear the window reveal when installed.

Measuring for controls

Looking at your window, work out which side will be the most convenient to operate the blind from and how long you would like the chain length would be. If the window is high up, a longer chain will hang lower and be easier to reach, while for full length windows a shorter chain may be suitable and out of reach of children. Generally, the chain length is made at 75% of the drop of your blind.

Roller blinds operate with a chain to raise and lower.

SHADE ELEMENTS

Interiors

Follow this guide to install your Dual Roller blinds

Getting started

Tools required;

- Pencil
- Tape measure
- Electric screwdriver
- #2 square drive

Inside Fit

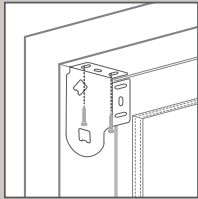

Step 1

1 x left hand double bracket
2 x screws

Fix the left hand double bracket inside the window frame in the top left hand cover of the window using two of the screws provided.

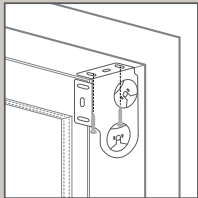

Step 2

1 x right hand double bracket
2 x screws

Repeat step 2 on the right side of the window, measuring the same distance back from the front of the frame.

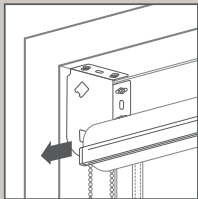

Step 3

Lift the sunscreen blind up to the window with the controls on the side selected when ordering.

Place the chain end into the bracket.

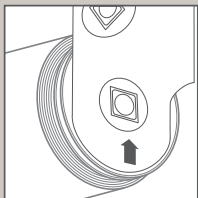

Step 4

Applying pressure on the pin end to depress the pin, gently push the blind up into the bracket until the pin end inserts into the bracket.



Step 5

Repeat step 3, inserting the blockout blind into the upper bracket. Be careful to set the chain into the chain diverter as shown.

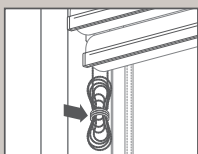

Step 6

Remove the rubber band from the chains to operate the blinds.



Step 7

4 x ball stops

Attaching ball stops ensures the blind is not wound up or down too far, preventing damage.



For each blind, roll the blind to the top of its range, note the position the chain meets the clutch housing and attach a ball stop. Then roll the blind to the bottom of its range, note the position on the chain and attach a ball stop.

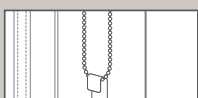

Step 8

2 x child safety tensioner with screw

Place the tensioner over the chains and let hang to determine where best to fix them to the window frame using the screws provided.

Being careful not to damage the blind or chain when removing the packaging, unpack the blind and check all parts are included;

- Dual roller blinds
- 1 pair of slimline double brackets
- 4 x ball stops
- 2 x child safety tensioner with screw
- 4 x screws

Outside Fit

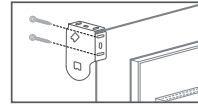

Step 1

1 x left hand double bracket
2 x screws

At the position originally measured from, fix the left hand bracket to the architrave or wall on the left side of the window using two of the screws provided. If positioning on the architrave, pre-drill the holes to prevent splitting. If fixing to the wall, you may need to pack out the brackets and use longer screws to allow the blind to clear the window reveal when installed.

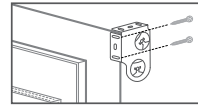

Step 2

1 x right hand double bracket
2 x screws

Repeat step 1 on the right side of the window.

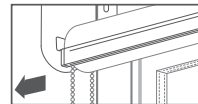

Step 3

Lift the sunscreen blind up to the window with the controls on the side selected when ordering.

Place the chain end into the bracket.

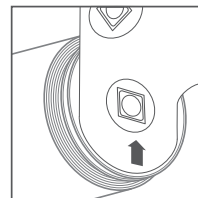

Step 4

Applying pressure on the pin end to depress the pin, gently push the blind up into the bracket until the pin end inserts into the bracket.



Step 5

Repeat step 3, inserting the blockout blind into the upper bracket. Be careful to set the chain into the chain diverter as shown.

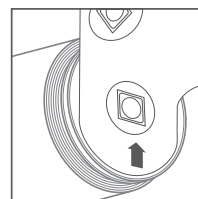

Step 6

Remove the rubber band from the chains to operate the blinds.



Step 7

4 x ball stops

Attaching ball stops ensures the blind is not wound up or down too far, preventing damage.

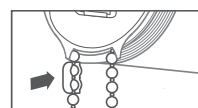

For each blind, roll the blind to the top of its range, note the position the chain meets the clutch housing and attach a ball stop. Then roll the blind to the bottom of its range, note the position on the chain and attach a ball stop.

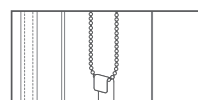

Step 8

2 x child safety tensioner with screw

Place the tensioner over the chains and let hang to determine where best to fix them to the window frame using the screws provided.